

SHIMANO STEPS

SHIMANO Total Electric Power System

SC-E7000 User's Manual

Cycle Computer

CONTENTS

IMPORTANT NOTICE	2
Important Safety Information	2
NOTICE	3
Regular inspections before riding the bicycle	3
Booklet Structure	5
Names of parts	6
Notation method for operations	7
Installing and removing the cycle computer	8
Basic operation	9
Turning the power ON/OFF	9
Viewing the screen.....	10
Turning the light ON/OFF	11
Switching the traveling data display	12
Setting menu	14
Switching to the setting menu	14
Returning to the main screen from the setting menu screen [Exit]	14
Setting the time [Clock]	15
Turning the operation sound ON/OFF [Beep]	15
Setting the display	16
Setting the assist bicycle function	18
Wireless connection	20
2.4 GHz digital wireless systems	20
ANT connection.....	20
Bluetooth® LE connection.....	20
Wireless system specifications	20
E-TUBE PROJECT	20
Troubleshooting	22
Recovering from the RD protection function [RD protection reset]	22
Gear shifting adjustment with the electronic gear shifting unit [Adjust]	22
Warning / error indication.....	23
When a problem occurs	27

IMPORTANT NOTICE

- Contact the place of purchase or a distributor for information on installation, adjustment, and replacement of the products which are not found in the user's manual. A dealer's manual for professional and experienced bicycle mechanics is available on our website (<https://si.shimano.com>).
- Please observe the appropriate rules and regulations of the country, state or region in which you conduct your business as a dealer.
- The Bluetooth® word mark and logos are registered trademarks owned by the Bluetooth SIG, Inc. and any use of such marks by SHIMANO INC. is under license. Other trademarks and trade names are those of their respective owners.

For safety, be sure to read this "user's manual" thoroughly before use, follow it for correct use, and store it so that it can be referenced at any time.

The following instructions must be observed at all times in order to prevent personal injury and physical damage to equipment and surroundings. The instructions are classified according to the degree of danger or damage which may occur if the product is used incorrectly.

DANGER

Failure to follow the instructions will result in death or serious injury.

WARNING

Failure to follow the instructions could result in death or serious injury.

CAUTION

Failure to follow the instructions could cause personal injury or physical damage to equipment and surroundings.

Important Safety Information

WARNING

- Do not disassemble or modify the product. This may cause the product to not operate correctly, and you may suddenly fall and be seriously injured.

Riding precautions

- Do not to pay excessive attention to the cycle computer display while riding. Doing so may result in an accident.
- Confirm that the light works before riding.

Safety precautions

- Be sure to remove the battery and charging cable before wiring or attaching parts to the bicycle. Failure to do so may cause an electric shock.
- Be sure to follow the instructions provided in the manuals when installing the product. It is recommended that you use SHIMANO genuine parts. Loose nuts or bolts and product damage may cause a sudden accident such as a fall and lead to serious injury.
- Do not leave this product in an extremely high temperature surrounding environment such as in a closed vehicle on a hot day, or near a heater. That can result in an explosion of the incorporated battery or the leakage of flammable liquid or gas from it.
- Do not subject this product to extremely low air pressure. That may result in an explosion of incorporated battery or the leakage of flammable liquid or gas from it. Transporting this product by air is not a problem.

Disposal precautions

- Observe all federal, state and local environmental regulations when disposing of this product, because it incorporates a battery. Disposal of this product into fire or a hot oven, or mechanically crushing or cutting of it, that can result in an explosion of the incorporated battery.

CAUTION

Riding precautions

- Observe the instructions in the manual for the bicycle in order to ride safely.

Safety precautions

- Never modify the system. Doing so may cause a system error.
- Use the product under the supervision of someone responsible for safety and upon receiving usage instructions. Do not allow anyone with reduced physical, sensual, or mental capacity, or those without experience or knowledge, to use the product, including children.

- Do not allow children to play near the product.

NOTICE

Safety precautions

- If any malfunction or trouble occurs, consult the place of purchase nearest you.
- Be sure to attach caps to any unused connectors.
- For installation and adjustment of the product, consult a place of purchase.
- The components are designed to be fully waterproofed to withstand wet weather riding conditions; however, do not deliberately place them into water.
- Do not clean the bicycle with a high-pressure washer. If water gets into any of the components, operating problems or rusting may result.
- Do not turn the bicycle upside down. There is a risk of damage to the cycle computer and switch unit.
- Handle the components carefully, and avoid subjecting them to strong shock.
- Although the bicycle still functions as a normal bicycle even when the battery is removed, the light will not turn on if it is connected to the electric power system. Be aware that using the bicycle under these conditions will be considered non-observance of the road traffic laws in Germany.

Connection and communication with PC

A PC linkage device can be used to connect a PC to the bicycle (system or components), and E-TUBE PROJECT can be used to carry out tasks such as customizing single components or the whole system and updating firmware.

- PC linkage device: SM-PCE1/SM-PCE02
- E-TUBE PROJECT: PC application
- Firmware: Software inside each component

Connection and communication with smartphone or tablet

- It is possible to customize single components or the system, and update firmware, using E-TUBE PROJECT for smartphones/tablets after connecting the bicycle (system or components) to a smartphone or tablet via Bluetooth® LE.
- E-TUBE PROJECT: Application for smartphones/tablets
- Firmware: Software inside each component

Care and maintenance

- Contact the place of purchase for updates of the component software. The most up-to-date information is available on the SHIMANO website.
- Do not use thinner or other solvents to clean any of the components. Such substances may damage the surface.
- For any questions regarding methods of installation and maintenance, please contact your place of purchase.
- Products are not guaranteed against natural wear and deterioration from normal use and aging.
- For maximum performance we highly recommend SHIMANO lubricants and maintenance products.

Labels

- Some of the important information contained in this user's manual is also indicated on the device label.

Regular inspections before riding the bicycle

Before riding the bicycle, check the following items. If any problems are found with the following items, contact the place of purchase or a distributor.

- Does the drive train perform gear shifting smoothly?
- Are the components fixed securely and free from damage?
- Are the components securely installed to the frame/handlebar/stem, etc.?
- Do any abnormal noises occur while riding?
- Is there sufficient charge remaining in the battery?

FCC compliance information

This device complies with part 15 of the FCC Rules.

Operation is subject to the following two conditions:

- (1) This device may not cause harmful interference, and
- (2) this device must accept any interference received, including interference that may cause undesired operation.

NOTICE: This equipment has been tested and found to comply with the limits for a Class B digital device, pursuant to part 15 of the FCC Rules. These limits are designed to provide reasonable protection against harmful interference in a residential installation. This equipment generates, uses and can radiate radio frequency energy and, if not installed and used in accordance with the instructions, may cause harmful interference to radio communications. However, there is no guarantee that interference will not occur in a particular installation. If this equipment does cause harmful interference to radio or television reception, which can be determined by turning the equipment off and on, the user is encouraged to try to correct the interference by one or more of the following measures:

- Reorient or relocate the receiving antenna.
- Increase the separation between the equipment and receiver.
- Connect the equipment into an outlet on a circuit different from that to which the receiver is connected.
- Consult the dealer or an experienced radio/TV technician for help.

Booklet Structure

SHIMANO STEPS user's manuals are split among several booklets, as described below.

Be sure to read these user's manuals thoroughly before use, and follow them for correct use. Store the user's manuals so that they can be referenced at any time.

The latest user's manuals are available on our website (<https://si.shimano.com>).

- **SHIMANO STEPS user's manual**

This is the basic user's manual for SHIMANO STEPS. It contains the following content.

- SHIMANO STEPS quick guide
- How to operate assist bicycles that use flat handlebars, such as city, trekking, or MTB type bicycles
- Troubleshooting

- **SHIMANO STEPS user's manual for drop handlebar bicycles (separate booklet)**

This booklet describes how to operate assist bicycles that use a drop handlebar and are controlled using a dual control lever. This should be read along with the SHIMANO STEPS user's manual.

- **SHIMANO STEPS special battery and parts user's manual**

It contains the following content.

- How to charge and handle the SHIMANO STEPS special battery
- How to attach and remove the SHIMANO STEPS special battery to the bicycle
- How to use the satellite system on/off switch and satellite charging port
- How to read the battery LEDs when charging or during an error, and how to handle errors

- **Cycle computer user's manual (this document)**

It contains the following content.

- Basic operations of the cycle computer and how to configure settings
- Wireless communication method
- How to handle errors/warnings and cycle computer troubleshooting

- **Switch unit user's manual**

This is the assist switch and shifting switch user's manual. Describes switch unit operations.

Names of parts

This product is operated with the function button on the main body and the switch unit included in the assist bicycle.

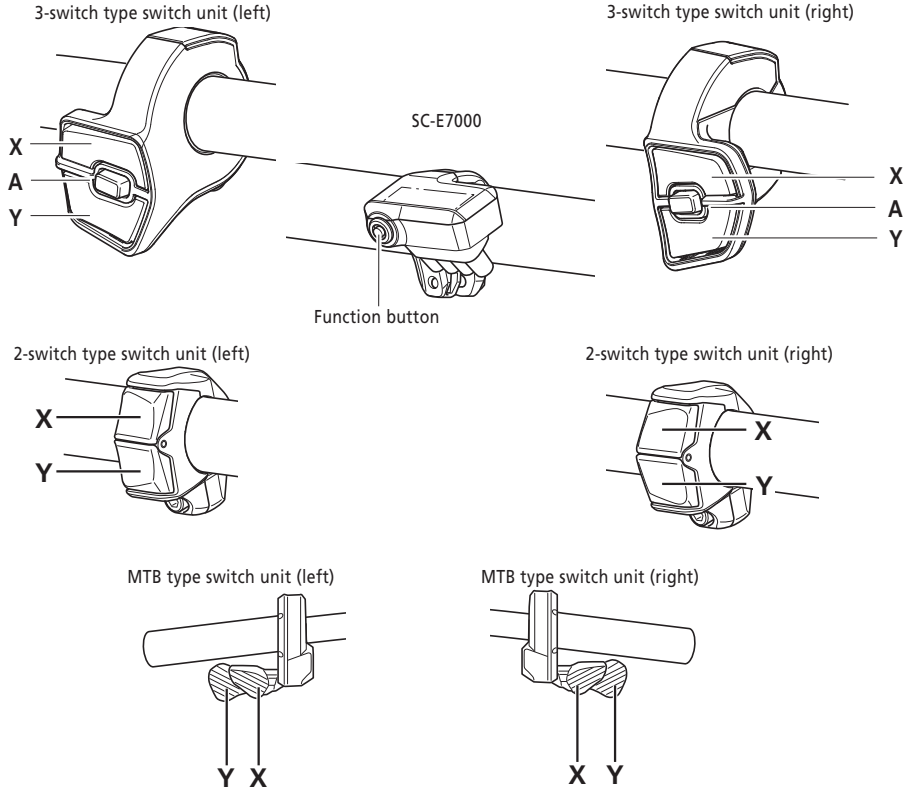

The operation for each button/switch is indicated below.

Cycle computer	
Function Button*1	When riding: Switching traveling data display When setting: Switch screen or confirm setting changes

*1 The operation performed when the button is held down differs according to whether a switch unit with an assist function assigned is connected.

- If a switch unit with an assist function assigned is connected: Display setting menu screen
- If a switch unit with an assist function assigned is not connected: Change assist mode

Switch unit (left) (default: for assist)		Switch unit (right) (default: electronic gear shifting)	
Switch-X	When riding: Increase assistance When setting: Move cursor or change setting	Switch-X	When riding: Shifting up
Switch-Y	When riding: Decrease assistance When setting: Move cursor or change setting	Switch-Y	When riding: Shifting down
Switch-A	When riding: Switching traveling data display When setting: Switch screen or confirm setting changes	Switch-A*1	When riding: Switch between automatic and manual gear shifting

*1 Only when the assist bicycle supports automatic gear shifting.



- This manual uses default settings for all explanations regarding the function assignment of the switch unit. The functions assigned to switches can be changed from those described here, by connecting to E-TUBE PROJECT. Please contact your place of purchase for details.
- The switch layout may differ according to the switch unit. Refer to the switch unit user's manual for details.

■ Notation method for operations

Subsequent operations using the main body button and switch unit of this product are indicated using the following notation.

Notation	Operation
<F>	Indicates an operation for pressing the function button.
<↑>	Indicates an operation for pressing the switch-X of the assist switch.
<↓>	Indicates an operation for pressing the switch-Y of the assist switch.
[Clock] (Example) Time setting	Items displayed on the cycle computer screen are enclosed in square brackets in this manual. When this notation is used in a procedure, it indicates an operation for selecting a display on the screen and pressing the function button or the switch-A of the assist switch to switch the screen or confirm the setting.
<A>	Indicates an operation for pressing the switch-A of the assist switch.



- Operations indicated with <F> may be performed with <A> instead.

Installing and removing the cycle computer

For the installation/removal procedure, contact the place of purchase or a distributor.

Basic operation

■ Turning the power ON/OFF

The power of this product is linked with the main power of the assist bicycle. When the main power is turned ON, all components connected to the drive unit of the assist bicycle are also turned ON (such as assist driving, the power of this product, the electronic gear shifting mechanism, and the lights).

For the procedure for turning the main power ON/OFF, refer to the SHIMANO STEPS user's manual.

NOTICE

- Before turning the power ON, please refer the SHIMANO STEPS special battery and parts user's manual to check the following.
 - The battery is firmly attached to the battery mount
- The power cannot be turned ON while charging.



- If the bicycle is left unused for 10 minutes after turning the power ON, the power automatically turns OFF (auto power OFF function).

When the main power is turned ON, a screen similar to that shown below is displayed, and then switches to the main screen.



SHIMANO
STEPS

■ Viewing the screen

The items displayed on the main screen differ according to the assist bicycle.

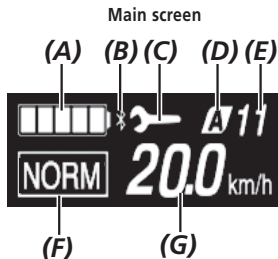

(A)	Battery level indicator (Refer to "Battery level indicator")	(E)	Gear position display *1 Displays the current gear position.
(B)	Bluetooth® LE icon Displayed when an external device is connected over Bluetooth® LE. (Refer to "Bluetooth® LE connection")	(F)	Current assist mode *2 The assist modes that can be selected differ according to the assist bicycle.
(C)	Maintenance alert Indicates that maintenance is required. Contact your place of purchase or a distributor if this icon is displayed.	(G)	Traveling data display *4 Displays traveling data such as the current speed. The traveling data that can be displayed differs according to the assist bicycle.
(D)	Gear shifting mode *3 [A]: Displayed for the auto gear shifting mode. [M]: Displayed for the manual gear shifting mode.		

*1 Only displayed for electronic gear shifting.







*2 Refer to the SHIMANO STEPS user's manual.

*3 For assist bicycles that cannot switch the gear shifting mode, the display is fixed to [A] or [M].

*4 Refer to "Switching the traveling data display".

Battery level indicator

The battery level is shown as an icon.

Display	Battery level
	100 - 81%
	80 - 61%
	60 - 41%
	40 - 21%
	20 - 1% *
	0%

* The battery level indicator will flash when the battery level is low.



- The cycle computer uses zero to indicate a battery level where assistance cannot be performed. With the SHIMANO STEPS system, the light can still be lit up for a while when assist stops due to a low battery. Therefore, the above-mentioned battery level may differ from that which can be checked on the battery.

■ Turning the light ON/OFF

If a light is connected to the drive unit, this product can be used to operate the light. Refer to "Turning the light ON/OFF [Light]".



- The light power is linked with the main power. The light cannot be turned ON when the main power is OFF.

■ Switching the traveling data display

On the main screen, you can check various traveling data in addition to the current speed. The traveling data that can be displayed differs according to the assist bicycle.

1. On the main screen: <F>



The traveling data switches in the following order each time <F> is pressed.

Display item	Explanation
-	Current speed
[DST]	Traveling distance
[ODO]	Cumulative distance
[RNG]	Traveling range*1
[TME]	Traveling time*2
[AVG]	Average speed*2
[MAX]	Maximum speed*2
[CAD]	Crank rotation speed*2*3
[CLK]	Current time*2

*1 Reference value. The value is displayed when the assist mode is set to a value other than [OFF] or [WALK].

*2 Whether to show this or not can be set with E-TUBE PROJECT.

*3 It is displayed when the assist mode is set to a value other than [OFF] or [WALK] with electronic gear shifting.



- If the traveling data display is switched when [CLK] is displayed, the screen will switch back to displaying the current speed.
- When the current speed and an item other than [CAD] is displayed, the screen will switch back to displaying the current speed if it is left unused for 1 minute.

Resetting the traveling distance

The traveling distance is reset from the main screen. When the traveling distance is reset, [TME] (traveling time), [AVG] (average speed), and [MAX] (maximum speed) will also be reset.

The traveling distance can also be reset from the setting menu. Refer to "Resetting the traveling distance [Clear]".

1. On the main screen: <F> (switches the traveling data display to [DST])



2. <F> (continue to hold until the number displayed for [DST] flashes)

3. When the number displayed for [DST] flashes: <F>

The traveling data is reset.



- If nothing is done for five seconds after the number for [DST] begins flashing, it will stop flashing and the screen will return to the main screen.

Setting menu

The items that can be set differ according to the assist bicycle. If assist switch is not connected, the setting menu cannot be displayed.

■ Switching to the setting menu

To display the setting menu, perform the following operation when the traveling data display is something other than [DST].

1. Stop the bicycle ⇒ <F> (continue to hold until the screen switches)



- You can also use the following methods to display the setting menu.
 - Stop the bicycle ⇒ <A> (continue to hold until the screen switches)
 - Stop the bicycle ⇒ <↑> + <↓> (continue to hold until the screen switches)

■ Returning to the main screen from the setting menu screen [Exit]

Closes the setting menu and returns to the main screen.

1. Setting menu screen ⇒ [Exit]

■ Setting the time [Clock]

1. Setting menu screen ⇒ [Clock] ⇒ <↑> or <↓> to change the "Hour" number ⇒ <F>
The cursor moves to the "Minute" number.



2. <↑> and <↓> to change the "Minute" number ⇒ <F>
The display will automatically return to the setting menu screen.



-
- Continue to hold <↑> or <↓> to change the number quickly.
-

■ Turning the operation sound ON/OFF [Beep]

Set whether to emit the operation sound.

1. Setting menu screen ⇒ [Beep] ⇒ [ON] / [OFF]
The display will automatically return to the setting menu screen.



-
- The beep sound for operation mistakes and system errors cannot be turned OFF.
-

■ Setting the display

Switching the font color [Font color]

1. Setting menu screen ⇒ [Font color] ⇒ [White] / [Black]
The display will automatically return to the setting menu screen.

Switching the display language [Language]

1. Setting menu screen ⇒ [Language] ⇒ select the display language ⇒ <F>
The display will automatically return to the setting menu screen.

Changing the unit of the speed and distance [Unit]

Select the unit for displaying the speed and distance.

1. Setting menu screen ⇒ [Unit] ⇒ [km] / [mile]
The display will automatically return to the setting menu screen.

Matching the displayed speed with another device [Display speed]

You can adjust the displayed value when there is a difference between the speed displayed on this product and the speed indicator of another device.

Setting items	Explanation
Increase value	Increases the displayed speed value.
Decrease value	Decreases the displayed speed value.

1. Setting menu screen ⇒ [Display speed] ⇒ <↑> or <↓> to adjust the value ⇒ <F>
The display will automatically return to the setting menu screen.

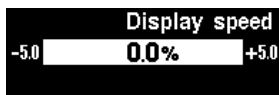

- This setting only changes the displayed value. It does not change the power assist function.

Resetting the traveling distance [Clear]

Resets the traveling distance. When the traveling distance is reset, [TME] (traveling time), [AVG] (average speed), and [MAX] (maximum speed) will also be reset.

1. Setting menu screen ⇒ [Clear] ⇒ [DST]

The display will automatically return to the setting menu screen.

■ Setting the assist bicycle function

Turning the light ON/OFF [Light]

Turns the light connected to the drive unit ON/OFF.

1. Setting menu screen ⇒ [Light] ⇒ [ON] / [OFF]
The display will automatically return to the setting menu screen.

Setting the gear position when starting from a stop [Start mode]

Automatically shifts to the set gear position when the bicycle starts from a stop.

Setting items	Explanation
[OFF]	Do not set the start mode.
[1], [2],...*1	Select the gear position.

*1 A gear position up to the maximum gear position of the shifting unit installed to the assist bicycle can be set.

1. Setting menu screen ⇒ [Start mode] ⇒ <↑> or <↓> to select the gear position ⇒ <F>
The display will automatically return to the setting menu.



Dynamically changing the riding comfort [Assist customize]

The riding comfort of the assist bicycle differs greatly according to the maximum torque of the drive unit and how much assistance is provided for pedaling. This product has multiple recommended settings registered that can be switched according to your preference. Details of the settings can be checked with E-TUBE PROJECT and the settings can be customized. Refer to the help manual for E-TUBE PROJECT for details.

Setting items	Explanation
[Profile 1]	Changes to the riding comfort registered in [Profile 1].
[Profile 2]	Changes to the riding comfort registered in [Profile 2].

1. Setting menu screen ⇒ [Assist customize] ⇒ [Profile 1] / [Profile 2]

NOTICE

Depending on the setting, battery consumption may increase and the assisted traveling range may greatly decrease.



- The settings may differ according to the assist bicycle. Refer to the manual for the assist bicycle.

Adjusting auto gear shifting [Shift timing]

Adjusts the gear shifting timing during automatic gear shifting.

Setting items	Explanation
Increase value	Increase the value when pedaling feels too heavy.
Decrease value	Decrease the value when pedaling feels too light.

1. Setting menu screen ⇒ [Shift timing] ⇒ <↑> or <↓> to adjust the value ⇒ <F>
The display will automatically return to the setting menu.



Wireless connection

This product has a wireless communication function.

■ 2.4 GHz digital wireless systems

2.4 GHz frequency digital wireless technology is the same thing as a wireless LAN. In rare instances, strong electromagnetic waves or electromagnetic interference due to the following locations or devices may impact communication.

- TVs, PCs, radios, motors/engines, or inside vehicles or trains
- Near railroad crossings and tracks, television transmitter stations, and radar stations
- Other wireless computers or digital control lights

■ ANT connection

All the information displayed on the main screen can be sent to an external device that supports ANT connections.

Connection method

When the main power is turned ON for SHIMANO STEPS, communication can be received at any time. Refer to the manual of the external device, switch the external device to connection mode, and then connect it.

■ Bluetooth® LE connection

All the information displayed on the main screen can be sent to an external device that supports Bluetooth® LE connections. E-TUBE PROJECT for smartphones/tablets may be used if a Bluetooth® LE connection is established with a smartphone/tablet. E-TUBE RIDE can be used to check traveling data on a smartphone connected over Bluetooth® LE.

Connection method

Communication can only be received under the following conditions. Refer to the manual of the external device, switch the external device to connection mode, and then connect it.

- Within 30 seconds of the main power for SHIMANO STEPS turning ON
- Within 30 seconds of operating any button/switch other than the SHIMANO STEPS power switch

■ Wireless system specifications

Model name	SC-E7000
Frequency band	2,402 - 2,480 MHz
Maximum high-frequency output	+4 dBm
Firmware version	4.0.0 or later

■ E-TUBE PROJECT

E-TUBE PROJECT is needed to change the setting of the SHIMANO STEPS and to update firmware.

Download E-TUBE PROJECT from our support website (<https://e-tubeproject.shimano.com>).

For information on how to install E-TUBE PROJECT, check the support website.

NOTICE

Do not connect to a device while the battery is being charged.



- Firmware is subject to change without notice.

Items configurable in E-TUBE PROJECT

The items that can be set differ according to the assist bicycle. Refer to the help manual for E-TUBE PROJECT for details.

- The functions assigned to each operation switch can be changed.
- The settings that can be configured from this product can also be configured from E-TUBE PROJECT.
- Riding comfort settings for the assist bicycle can be retained and registered in this product. (Refer to "Dynamically changing the riding comfort [Assist customize]")

■ Recovering from the RD protection function [RD protection reset]

In order to protect the system from falls etc., the RD Protection function will operate when the rear derailleur is subjected to a strong impact. The connection between the motor and the link will be momentarily severed so that the rear derailleur can no longer operate.

When RD Protection Reset is run, it will restore the connection between the motor and the link, and recover the rear derailleur from RD Protection.



- This function is enabled for electronic gear shifting rear derailleur models only.

1. Setting menu ⇒ [RD protection reset] ⇒ [OK]

An illustration of a crankset is displayed on the screen.

2. Turn the crank clockwise with the rear wheel lifted up.

The rear derailleur moves, and the connection between the motor and link is restored.



■ Gear shifting adjustment with the electronic gear shifting unit [Adjust]

If gear shifting feels abnormal, contact the place of purchase.

■ Warning / error indication

The PC version of E-TUBE PROJECT classifies errors and warnings into more detailed categories according to the cause. For this reason, the error and warning codes that are displayed in the PC version of E-TUBE PROJECT may differ from those displayed on personal cycle computers, E-TUBE RIDE, or E-TUBE PROJECT for smartphones / tablets.

Warning indication

If the situation is resolved, this indication will disappear. If the situation does not improve, contact the place of purchase.



Code*1	Indication conditions	Operational restrictions being displayed	Remedy
W101 (W011)	Traveling speed not detected.	The maximum speed up to which assist is provided will be lower than normal.	Have your place of purchase perform the following. <ul style="list-style-type: none"> • Check to see if the speed sensor is installed in the correct position. • Check to see if the magnet on the disc brake rotor is attached. (Refer to the "Disc brake" section in "General operations" for how to install the removed magnet.)
W103 (W013)	Initialization did not complete normally for the torque sensor.	Assistance will be lower than normal.	Press the battery power button without stepping on the pedal to turn the power ON again.
W104	Current leakage detected in the system and power turned OFF.	Assist will not be provided when riding.	Have your place of purchase perform the following. Remove the components other than the drive unit one by one, then turn the power back ON. <ul style="list-style-type: none"> • If the component with a problem has not been removed, the power turns OFF during startup. • If the component with a problem has been removed, the power turns ON and W104 remains displayed.
W105	Unexpected power disconnection detected.	-	Refer to the "SHIMANO STEPS User's manual" and turn the power OFF and then ON again. If W105 is displayed frequently, have your place of purchase perform the following. <ul style="list-style-type: none"> • Check to see if the battery holder rattles or if the power cord is disconnected.
W200 (W020)	If the temperature exceeds the guaranteed operating range, the battery output stops.	No system functions will start.	If the temperature is higher than the temperature at which discharging is possible, leave the battery in a cool location with no direct sunlight until the internal temperature of the battery has decreased sufficiently. If the temperature is lower than the temperature at which discharging is possible, leave the battery indoors until the internal temperature has increased to an appropriate temperature.

Code*1	Indication conditions	Operational restrictions being displayed	Remedy
W302 (W032)	Shifting unit different from system configuration is installed.	Unable to perform gear shifting.	Have your place of purchase perform the following. Replace with the shifting unit configured in the system. Or check the current system status with E-TUBE PROJECT.

*1 The instruction in the parentheses is displayed according to the drive unit connected.

Error indication

If an error message is displayed on the entire screen, refer to the SHIMANO STEPS special battery and parts user's manual and follow one of the procedures below to reset the display.

- Press the battery power button to turn the power OFF.
- Remove the battery from the battery mount.



NOTICE

- If the situation does not improve even after turning the power back ON, consult with the place of purchase or a distributor.

Code*1	Indication conditions	Operational restrictions being displayed	Remedy
E010	System error detected.	Assist will not be provided when riding.	Refer to the "SHIMANO STEPS User's manual" to turn the power OFF and then ON again. If the situation does not improve, contact the place of purchase or a distributor.
E020	Communication error between the battery and drive unit detected.	Assist will not be provided when riding.	Have your place of purchase perform the following. <ul style="list-style-type: none"> • Check to see if the cable between the drive unit and battery is connected correctly.
E021	Battery connected to drive unit conforms with system standards but is not supported.	Assist will not be provided when riding.	Have your place of purchase perform the following. <ul style="list-style-type: none"> • Connect a genuine SHIMANO battery. Also check the power cord for abnormalities. If the error persists, contact your distributor.
E022	Battery connected to drive unit does not conform with system standards.	No system functions will start.	Have your place of purchase perform the following. <ul style="list-style-type: none"> • Connect a genuine SHIMANO battery. Also check the power cord for abnormalities. If the error persists, contact your distributor.
E023	Electrical abnormality in battery detected.	No system functions will start.	Have your place of purchase perform the following. <ul style="list-style-type: none"> • Connect a genuine SHIMANO battery. Also check the power cord for abnormalities. If the error persists, contact your distributor.
E024	Battery overcurrent protection occurred.	No system functions will start.	Have your place of purchase perform the following. <ul style="list-style-type: none"> • Connect a genuine SHIMANO battery. Also check the power cord for abnormalities. If the error persists, contact your distributor.
E025	Battery does not recognize the drive unit.	No system functions will start.	Have your place of purchase perform the following. <ul style="list-style-type: none"> • Connect a genuine SHIMANO battery. Also check the power cord for abnormalities. If the error persists, contact your distributor.

Code*1	Indication conditions	Operational restrictions being displayed	Remedy
E030	Shifting unit different from system configuration is installed.	Assist will not be provided when riding.	Have your place of purchase perform the following. Replace with the shifting unit configured in the system. Or check the current system status with E-TUBE PROJECT.
E033	Current firmware is not supported by this system.	Assist will not be provided when riding.	Have your place of purchase perform the following. <ul style="list-style-type: none"> • Connect to E-TUBE PROJECT to update the firmware on all the assist bicycle units to the latest version.
E034 (E013)	Abnormality detected in drive unit's firmware.	Assist will not be provided when riding.	Contact your place of purchase or a distributor. The firmware needs to be restored.
E035	Configuration error.	Assist will not be provided when riding.	Have your place of purchase perform the following. Connect to E-TUBE PROJECT to check the configuration.
E043	Abnormality detected in firmware on this product. Part of the firmware may be corrupted.	Assist will not be provided when riding.	Contact your place of purchase or a distributor. The firmware needs to be restored.
E050 (E014)	Speed sensor may be installed in an incorrect position.	Assist will not be provided when riding.	Have your place of purchase perform the following. Check to see if the speed sensor is installed in the correct position. If not installed in the correct position, install it in the correct position and ride the bicycle for a while. Doing so should fix the error. If the error persists, contact your distributor.

*1 The instruction in the parentheses is displayed according to the drive unit connected.

■ When a problem occurs

Symptoms	Possible cause	Remedy
The screen of the cycle computer does not turn on.	The (main) battery level may be too low.	Refer the SHIMANO STEPS special battery and parts user's manual to charge the battery, and then turn the power ON again.
	Is the power ON?	Refer the SHIMANO STEPS special battery and parts user's manual to turn the power ON.
	Is the battery charging?	When charging with the battery installed to a bicycle, you cannot turn the power ON. Stop charging.
	Is the connector of the electric wire installed correctly?	Check whether the connector of the electric wire is disconnected. If you are not sure, contact the place of purchase.
	A product that the system cannot identify may be connected.	Contact the place of purchase.
The gear position is not displayed.	The gear position is only displayed when the electronic gear shifting unit is installed.	Check whether the connector of the electric wire is disconnected. If you are not sure, contact the place of purchase.
I want to turn the operation sound OFF.		Refer to "Turning the operation sound ON/OFF [Beep]".
Cannot start the setting menu while riding.	The product is designed to prevent the setting menu from being started while riding is detected. This is normal.	Configure the settings after stopping.
A switch operation cannot be performed and two beeps are heard.	Operation of the switch you pressed is prohibited.	This is not a malfunction.
Three beeps are heard.	An error or warning has occurred.	A warning or error is displayed on the cycle computer. Refer to "Warning indication" "Error indication".
The gear position set in the start mode is not set when the bicycle is stopped.	You may have pressed the pedal too strongly.	Pressing the pedal gently makes it easier to shift gears.

SHIMANO

SHIMANO NORTH AMERICA BICYCLE, INC.

One Holland, Irvine, California 92618, U.S.A. Phone: +1-949-951-5003

SHIMANO EUROPE B.V.

High Tech Campus 92, 5656 AG Eindhoven, The Netherlands Phone: +31-402-612222

SHIMANO INC.

3-77 Oimatsu-cho, Sakai-ku, Sakai City, Osaka 590-8577, Japan

Please note: specifications are subject to change for improvement without notice. (English)

© Apr. 2020 by SHIMANO INC. ITP