

AVINOX DRIVE SYSTEM

User Manual

2026.04

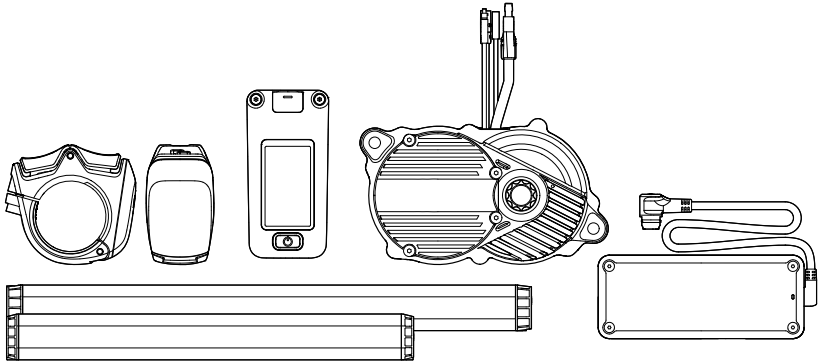



This document is copyrighted by Avinox with all rights reserved. Unless otherwise authorized by Avinox, you are not eligible to use or allow others to use the document or any part of the document by reproducing, transferring, or selling the document. Users should only refer to this document and the content thereof as instructions to operate Avinox products. The document should not be used for other purposes.

Using this Manual

Legend

Symbols Used in Texts

 Warning! Potential Hazards

 Note

Symbols Used in Illustrations

 Apply grease

 Apply threadlocker

Important Information

- The drive system can be only installed on compatible electric bicycles (hereinafter referred to as bikes) to use.
- Before using the bike equipped with the drive system, make sure you are completely familiar with the product functions, read and adhere to all the instructions from the bike manufacturer.
- Strictly abide by local laws and regulations when riding.
- Never make any unauthorized modifications to the drive system.
- Never disassemble the product without authorization, as this may cause damage.
- Contact the bike manufacturer to replace the parts of the drive system using original parts if required.
- If any components of the drive system need to be replaced, use only identical parts or those expressly approved by the manufacturer.
- Never power on the drive system until you are fully prepared. Otherwise, the unexpected acceleration may lead to accidents.
- Make sure to pay attention to safety during riding and avoid being distracted by the bike screen.

- The range estimate provided by the app is for reference only. Make sure to plan your trip according to the riding conditions before setting out.
- Follow the assembly instructions provided by the bike manufacturer to install the drive system.
- Watch out for the people nearby to avoid injury while riding.
- Ensure electrical connectors remain clean and dry. Never apply any grease or adhesives to the connectors. Avoid exposure to humid or dusty environments to prevent short circuits. Ensure connections are securely fastened when installing the electrical components.

Contents

Using this Manual	2
Legend	2
Important Information	2
1 Drive System Ecosystem	6
1.1 Drive System Main Components	6
1.2 Accessories	7
1.3 Specifications	7
2 System Operation and Interaction	8
2.1 Downloading Avinox Ride App	8
2.2 Pairing and Activating	8
2.3 Binding Key Code	8
2.4 Updating Devices	9
2.5 Button Features	9
2.6 Operating the Control Display	10
3 Assist Modes	11
3.1 Standard Modes	11
3.2 Walk Mode	11
3.3 Boost Mode	12
3.4 Custom Assist Modes	12
4 Intelligent Functions	13
4.1 Bike Connectivity	13
Installing the nano-SIM Card (DP100-F)	13
Enabling Bike Connectivity	14
4.2 Ride Data Sync	14
4.3 Bike Protection	15
Password Authentication	15
Mobile Key Unlock	15
Abnormal Movement Alerts	15
Remote Bike Control	16
Disabling Bike Protection	16
4.4 Setting Control Display	17
4.5 Control Display Navigation	17
Preparing Routes	17
Sending Route	18
Managing Imported Routes	18
Using Control Display Navigation	18

4.6	Adding Accessories	18
4.7	Smart Heart Rate Control	19
4.8	SmoothShift	20
4.9	Advanced Features	20
5	Battery Management	21
5.1	Dual Battery System	21
	Using Dual Battery System	21
5.2	Battery Safety Notice	21
	Charger Indicator	22
5.3	Battery Maintenance	23
5.4	Disposal	23
6	Maintenance	24
6.1	Routine Maintenance	24
6.2	Replacing Battery of Controller	25
7	Troubleshooting	26
7.1	Uploading Log	26

1 Drive System Ecosystem

1.1 Drive System Main Components

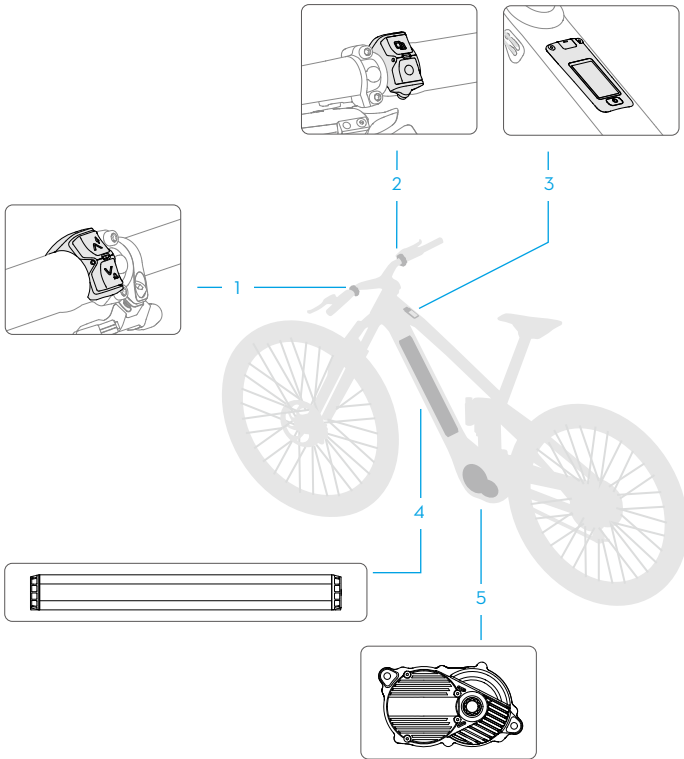

No.	Overview
1	Wireless Controller
2	Control Display
3	Battery
4	Drive Unit
5	Speed Sensor

1.2 Accessories

Avinox also provides accessories designed to work with the drive system. Visit the link below for more details:

<https://www.avinox-ebike.com/accessories>

1.3 Specifications

Visit the following website for specifications.

<https://www.avinox-ebike.com>

2 System Operation and Interaction

2.1 Downloading Avinox Ride App

Scan the QR code to download the latest version.



Once the drive system is paired with the Avinox Ride app via Bluetooth, users can customize the assist parameters and control display, and enable Bike Protection function in the app.

-
- 💡 • The interface and functions of the app may vary as the software version is updated. Actual user experience is based on the software version used.
 - To check the Android and iOS operating system versions supported by the Avinox Ride app, visit <https://www.avinox-ebike.com/avinox-system/downloads>.
-

2.2 Pairing and Activating

When powered on for the first time, follow the prompt on the control display to complete pairing and activation. Tap Skip and you can ride for a trial without activation. After the trial distance has run out, follow the steps below to pair and activate before you can continue to use it.

1. Press and hold the power button of the control display to power on.
2. Swipe up to enter Settings and tap **Pair With App** to view the QR code.
3. Make sure Bluetooth and network are enabled on your mobile device. Open the Avinox Ride app, then tap **Pair** and scan the QR code to pair.

2.3 Binding Key Code

-
- 💡 • The key code binding feature is only available for bikes with a removable battery and a battery key.
-

After activating the bike, the Avinox Ride app will enter the **Bind Key Code** interface. Scan the barcode on the key with the app to complete the binding. Once successful, go to the

app's home screen and tap **About Devices > Key Code** to view it. Keep your key safe. If lost, contact the bike manufacturer, and provide the bound key code for a replacement.

2.4 Updating Devices

When connected with the drive system, there will be a prompt in the app if a version update is available. It is recommended to update to the latest version to get a better user experience.

Make sure there is enough battery power before updating. During the update, make sure the signal on your phone is strong, and that the Bluetooth connection remains stable. Do not move the bike or power off the control display.

2.5 Button Features

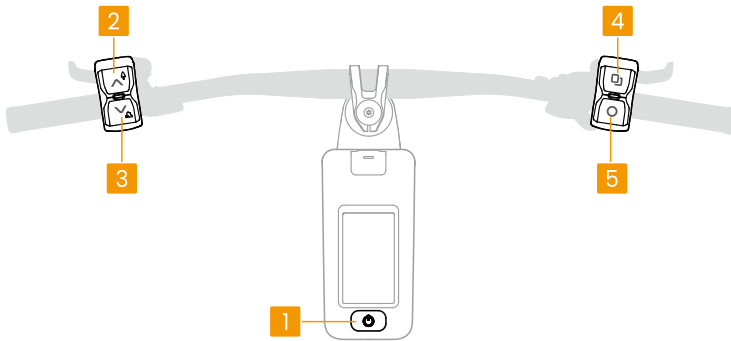

1. Power Button



- Press and hold to power on/off. Press and hold for 20 s to force power off.
- After powering on, press to cycle through the different assist modes.

2. ^ Assistance Level Increase Button

- Press to change to the next assist mode.
- Press and hold to activate Boost mode and the control display will display a countdown. Press the power button or any button on the left wireless controller to exit Boost mode.

3. v Assistance Level Decrease Button

- Press to return to the previous assist mode.

- Press and hold and then release the button to activate Walk mode. Once activated, press and hold the button to get power assistance to help pushing the bike uphill. Press the power button or any other button to exit Walk mode.
4.  **Screen Switch Button (customizable)**
- Press to scroll right through the display pages.
 - Swipe up on the control display to enter Settings, and then you can customize functions for the button in **Customize Controls**.
5.  **Function Button (customizable)**
- Press to scroll left through the display pages. When the control display is on Settings page, press once to return to the previous page.
 - Swipe up on the control display to enter Settings, and then you can customize functions for the button in **Customize Controls**.

2.6 Operating the Control Display

After the control display is powered on, it will show the home screen page. Tap or swipe on the screen to interact with the control display.

- Home Screen: Display the basic information.
- Swipe left: Enter the ride data pages, which can be customized in the app.
- Swipe right: Enter Control Center.
- Swipe up: Enter Settings to add accessories, set the recording mode and more.

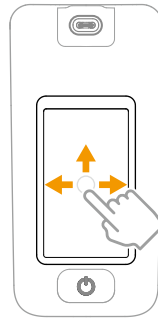

3 Assist Modes

The drive system provides four standard assist modes: Auto, Eco, Trail, and Turbo, and also supports Boost mode with high power output and Walk mode.

-
- Refer to the [Button Features](#) section to learn how to switch the assist modes.
 - When connected to the app, users can customize the assist parameters. Refer to [Custom Assist Modes](#) for more details.
-

3.1 Standard Modes

On the control display or in the app, tap **Custom Assist Modes** to view the assist parameters for Auto, Eco, Trail, and Turbo, and adjust them according to your riding preferences and scenarios.

The four standard modes offer varying level of assistance to handle different riding scenarios.

Auto: This mode automatically adjusts assistance based on different riding situations, providing a moderate level of assistance to enhance the range.

Eco: With gradual start-up acceleration and lower assistance, this mode conserves battery energy and is suitable for long-distance flat terrain riding.

Trail: This mode provides moderate start-up acceleration and stronger assistance and is suitable for cross-country technical route.

Turbo: This mode provides maximum assistance and is suitable for steep slopes.

3.2 Walk Mode

Press and hold  to activate Walk mode, then press and hold the button to get power assistance when pushing the bike or starting on an incline. It also supports auto hold to prevent rollback on slopes.

The assistance will shut off automatically when stop pressing  or the speed exceeds 6 km/h. Press the power button or any other button to exit Walk mode.

Stationary Gear Shifting

Stationary gear shifting is supported when using Walk mode. After activating Walk mode, press the shift controller and lift the rear wheel, then press  twice to shift gears quickly.

-
-  Only use Walk mode when pushing the bike. Using in inappropriate situations may cause accidents and personal injury.

- Make sure to keep your body away from the rotating crank and pedals to avoid injury when using Walk mode to assist pushing the bike and gear shifting.
-

3.3 Boost Mode

Boost mode delivers a temporary surge of extra power. Press and hold  to activate Boost mode. A countdown will begin on the control display. Pedaling during the countdown provides greater assistance, making it ideal for tackling challenging obstacles or steep climbs.

Boost mode will exit automatically when the countdown ends. To exit Boost mode early, press the power button or any button on the left wireless controller.



Before use, make sure Boost mode is enabled in the **Custom Assist Modes** setting on the control display or in the app.

Boost Local Enhancement

In the **Custom Assist Modes** setting on the control display or in the app, you can enable **Boost Local Enhancement**. Once enabled, the motor outputs the power and torque specific to Boost mode when activated, while the other parameters remain unchanged.



If **Boost Local Enhancement** is enabled, switching directly from Off mode to Boost mode will result in no motor assistance. Please be aware of this functional characteristic to avoid riding hazards.

3.4 Custom Assist Modes

Users can create new assist modes tailored to their riding preferences. Tap **Custom Assist Modes** in the app, then tap + to add a new assist mode and customize its parameters.



- Make sure the drive system is powered on and connected to the app when setting the assist modes.
 - Tap  to adjust the order of the assist modes, hide or delete certain custom modes.
-

4 Intelligent Functions

4.1 Bike Connectivity

With the nano-SIM card installed, the drive system can be connected to the app via mobile data. Users can remotely control the bike and check bike status.

💡 Only specific control display models support nano-SIM card installation.

Installing the nano-SIM Card (DP100-F)

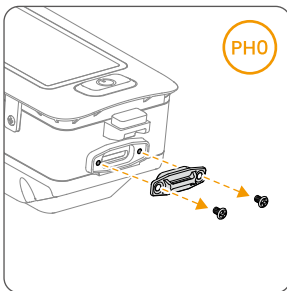
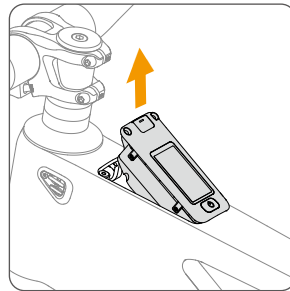
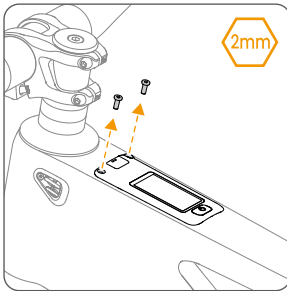

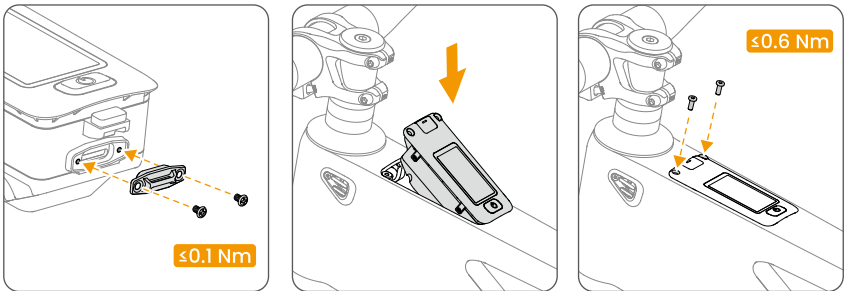

- Purchase a 4G nano-SIM card from an authorized carrier. Some bike models include a nano-SIM card in the packaging, or come with one pre-installed in the control display.
- If the nano-SIM card is set with a PIN code, make sure to insert the nano-SIM card into the mobile phone and cancel the PIN code setting. Otherwise, the control display will fail to connect to the internet.
- When removing from the frame, it is recommended to pry up the control display using a tool instead of pulling the Type-C port cover.

Enabling Bike Connectivity

After inserting the nano-SIM card, power on the control display and open the app, then enable **Bike Connectivity (SIM)** on the home screen.

Swipe up on the control display to check the signal. If the signal is normal, the connection status will display 4G in the app after turning off the Bluetooth on the mobile phone.

- If the control display displays no signal, check if the nano-SIM card is correctly inserted and working normally. If there is no issue with the nano-SIM card, check if the signal is good in the area.

4.2 Ride Data Sync

Open the app, tap  > **Terms & Privacy** > **Cloud Sync & Backup**, and enable **Cloud Sync & Backup**. Once enabled, ride data can be synced and backed up using the mobile network. The synced ride data can be viewed on other devices by logging into the account.

4.3 Bike Protection

The drive system provides Bike Protection functions, allowing users to set a digital password and use the phone as the Bluetooth key to unlock the bike automatically. If the bike is moved by accident, it will sound an alarm and the app will also receive a notification.

-
-  The Bike Protection functions may not be available for extended use when the bike is in an environment below 0° C (32° F) or the battery level is lower than 5%.
 - The Bike Protection functions can only be set when the bike and mobile phone are connected via Bluetooth.
 - The notifications can be pushed to the mobile phone only after enabling the app notification permission on the phone.
-

Password Authentication

Open the app, tap **Bike Protection** and then **Password Authentication**. Follow the instructions to set the password.

Once setup is complete in the app, restart the control display. The screen will prompt you to enter a password to unlock, indicating that Password Authentication is now enabled.

Mobile Key Unlock

After enabling Password Authentication, you can then enable Mobile Key Unlock.

1. Open the app, tap **Bike Protection** and then enable **Mobile Key Unlock**. Once enabled, the bike will be automatically locked when powered off.
2. When you return to the bike with your paired mobile phone, powering on the control display to unlock instantly, no password needed.

-
-  The drive system will power off and be locked automatically when the parking time exceeds the set duration of auto power off.
 - It is recommended to also use a physical lock for added security.
-

Abnormal Movement Alerts

After enabling Password Authentication, users can activate the Abnormal Movement Alerts function.

1. Open the app, tap **Bike Protection**, and then enable **Abnormal Movement Alerts**.

2. Once enabled, if abnormal movement is detected while the bike is locked:
 - The control display will sound an alarm and an alert will display on the screen.
 - The app will push a notification at the same time.

 The abnormal movement will trigger a notification in the app only if the bike and mobile phone remain connected. Otherwise, only the control display will sound an alarm.

3. Tap **View Bike Location** in the app. When the bike and the mobile phone are connected, you can check the bike location on the map.
 - If the alarm is unnecessary, tap **Beep Off & Keep Locked**. The beep will stop and the bike will remain locked.
 - To unlock the bike for someone else, tap **Authorize & Unlock** in the app or tap **Cancel** on the control display and enter the password. The beep will stop and the bike will be unlocked.

 After tapping **Authorize & Unlock**, the Abnormal Movement Alerts function will be disabled for an hour. During this period, moving the bike will not trigger the alarm.

4. To disable the function temporarily, go to **Bike Protection** in the app, tap **Disable Temporarily** and choose the duration.

Remote Bike Control

When the bike is connected with the mobile phone via Bluetooth or mobile data, tap **Security** in the app to view the regularly updated bike location and status. If movement is detected, the app will also display the movement track. If the control display is powered on, tap **Beep** to enable the bike to sound an alarm.

-
-  When connected to the bike via Bluetooth, users can power on the bike using the app.
-

Disabling Bike Protection

Users can disable the bike protection functions in the app. It is required to enter the password when disabling the password authentication function. Once disabled, mobile key unlock and abnormal movement alerts functions will no longer be available. Users can also disable these two functions individually with the password authentication function still enabled.

4.4 Setting Control Display

Open the app and tap **Bike Screen Display** to edit, add, and delete the data pages on the control display. After selecting a page, you can change the layout and replace data items in the page.

-
-  Before setting, make sure the drive system is powered on and connected to the mobile phone.
-

4.5 Control Display Navigation

Once navigation routes are sent to the control display using the Avinox Ride app, navigation information will be shown on the control display during your ride.

Preparing Routes

There are multiple ways to prepare your navigation routes in the Avinox Ride app.

Importing Local Files



1. On the app home screen, tap  to enter the navigation page.
2. Select **Local File**, tap +, then choose a local route file and import it.

Importing from Third-Party Platforms

1. On the app home screen, tap  > **Bind to Third-Party Account**, and follow the instructions to complete the setup.
2. The riding routes from the third-party platform will automatically appear on the navigation page.

-
-  To sync routes from Komoot, the route must be saved in the Komoot app and the corresponding map must be unlocked first. Otherwise, the route cannot be synced even if the account is bound.
-

Generating a Navigation Route From Ride Data

1. On the app home screen, tap  to enter the ride data page.
2. Select a ride data record, tap  to generate a navigation route based on this record.

Sending Route







1. Power on the control display. Ensure the bike and the mobile phone are connected via Bluetooth.
2. After selecting the route in the app, tap **Send to Device**. The route will be sent to the control display.

Managing Imported Routes

Swipe up on the control display, then select **Navigation > Imported** to view the imported routes.

Tap any route, then swipe up to view its details. Tap **Delete** to remove the route.

Using Control Display Navigation

-  After you get to the starting point of the route, make sure the bike has acquired a GNSS signal before starting navigation.
-
1. On the navigation page of the control display, select the route and tap **Start Navigation**.
 2. Tap  to preview the entire route, and tap  to switch back to navigation mode. Tap  to temporarily exit the navigation interface. The navigation task will keep running in the background. Swipe right on the control display to open Control Center, then tap the ongoing navigation task to return to the navigation interface.
 3. Tap any blank area on the navigation interface, and  will appear on the display. Tap  and follow the prompt to end navigation.
-
-  **Turn Alarm** function is enabled by default. A turn prompt will appear on the control display and a beep will sound as a turn approaches.
-

4.6 Adding Accessories

The drive system is able to connect with various accessories, providing more ways to record data during riding.

-  • It is not supported to connect to multiple accessories of the same type simultaneously. Disconnect from the previous device before pairing with a new one.

- When connecting a new wireless controller, press and hold the up and down buttons on the wireless controller simultaneously until the indicator flashes green and then follow the instructions to connect.

1. Press and hold the power button of the control display to power on, and then power on the accessory.
2. Swipe up to enter Settings. Tap **Accessories** > **Add** and the system will start searching for nearby devices.
3. Tap the device name displayed on the control display to start pairing. Follow the on-screen instructions to complete the connection.

The added devices are displayed on the **Accessories** page. Tap the device name to view the detailed information. Tap **Forget Device** to unpair with the device.

4.7 Smart Heart Rate Control

After **Smart Heart Rate Control** is enabled, the motor will dynamically adjust the assistance based on your real-time heart rate during riding. Some parameters in the assist modes cannot be customized while this feature is enabled.

Connecting a Heart Rate Monitor

1. Press and hold the power button of the control display to power on, and then power on the heart rate monitor.
2. Enable heart rate broadcasting on the heart rate monitor.
3. Swipe up on the control display to enter Settings. Tap **Accessories** > **Add Accessory**, and the system will start searching for nearby devices.
4. Tap the displayed device name to start pairing. Follow the on-screen instructions to complete the connection.



- Different heart rate devices have different ways to enable heart rate broadcasting. For details, refer to the user guide provided by the device manufacturer.
- Different control displays and heart rate monitors support different connection protocols. Switch between ANT+ pairing or Bluetooth pairing according to the supported protocol of your device.

Using Smart Heart Rate Control

1. Tap **Custom Assist Modes** on the home screen in the app, or swipe up on the control display to open the settings page and then tap **Custom Assist Modes**. Tap the icon in the upper-right corner and enable **Smart Heart Rate Control**.

2. Set your **Target Heart Rate, Fluctuation Range, and High Heart Rate Alert.**

You can view your current heart rate on the control display. During your ride:

- If your current heart rate is too low, the system will appropriately reduce the assistance so that you put in more effort and your heart rate gradually increases.
- If your current heart rate is high, the system will increase the assistance to reduce your pedaling effort and bring your heart rate back into the set range.
- When your heart rate goes above or below the set range, the system will beep and display a pop-up alert, prompting you to adjust your riding pace.
- If you receive a high heart rate alert, reduce your exercise intensity, or consider stopping the ride to avoid accidents.

4.8 SmoothShift

Power on the control display and swipe up, then tap **SmoothShift** to enable the function. Once enabled, you can complete gear shifts without pedaling when starting, descending, or preparing to stop.

 This function requires a compatible derailleur. Check the on-screen instructions for specific model requirements.

 Enable this function only when necessary. Use with caution when it is enabled.

4.9 Advanced Features

Swipe up on the control display to open the settings page, then tap **Advanced Features** to enable functions such as **Gear Shifting Suggestions, Extreme Attitude Protection, Freehub Pre-Engagement, Quick Start, Chain Protection,** and more. Check the on-screen descriptions for more details about each feature.

5 Battery Management

5.1 Dual Battery System

This bike supports the dual battery system. In addition to the main battery inside the down tube, an optional secondary battery can be installed at the water bottle cage position to extend the overall riding range.

-  The secondary battery is only supported in countries and regions where permitted by local laws and regulations.
- Installing the secondary battery requires a compatible mounting kit and connection cable. The secondary battery, mounting kit, and connection cable are all sold separately.

Using Dual Battery System

1. **Check Battery Status:** On the app home screen, tap **Battery** to view the remaining charge of both the main battery and secondary battery, and set their respective charging limits.
 2. **Battery Settings:** Swipe up on the control display to enter Settings, tap **Accessories** to view the currently installed secondary battery, then tap it to enter the settings page. You can also check the charge levels of both batteries in the Control Center, and tap to open the battery settings page.
 - **Auto Switch On:** The system automatically manages the discharge sequence. It prioritizes the secondary battery for discharge. Once it reaches a low battery level, the system seamlessly switches to the main battery.
 - **Auto Switch Off:** Manually switch between the main battery and the secondary battery.
-  If a fault occurs with the active battery, the control display will prompt you to switch batteries. Switching batteries will automatically disable **Auto Switch**.

5.2 Battery Safety Notice

Usage

- Do not use non-original batteries and chargers.
- Do not expose the battery to liquids. If the battery has water seep inside, do not use or charge it again and contact bike manufacturer for assistance.

- Do not disassemble or pierce batteries in any way.
- The electrolytes in the battery are highly corrosive. If any electrolytes come into contact with your skin or eyes, immediately wash the affected area with water and seek medical support.
- Do not leave the batteries near heat sources or in a high temperature environment.
- Avoid any impact to the battery. Otherwise, the battery may be damaged. Do not use a battery if it is involved in a crash or heavy impact.
- Keep the batteries out of the reach of children.
- Handle the battery with care during installation and removal. Never drop the battery.
- When the connection cable for the secondary battery is not connected, ensure the charging port cover is securely closed after charging and during rides.

Charging

- Do not continue to use if the charger port or cable shows signs of wear or other damage.
- Disconnect the battery from the charging device when it is fully charged. Do not overcharge the battery. Otherwise, the battery cells may be damaged.
- The battery life may be reduced if it is charged at a high temperature. After each ride, allow the battery to cool down to approximately room temperature before charging. Charging the battery at a temperature of 0° to 40° C (32° to 104° F) can extend the battery life significantly.
- Do not charge in a wet environment, and make sure the charging port is dry. Keep the battery well-ventilated and cool.
- Do not charge the battery unattended. Do not move the bike or rotate the cranks while the charger is plugged.
- This product is not intended for persons with physical, mental, or sensory impairments.
- To avoid burns, do not touch the charger with your hands while charging.

Charger Indicator

Solid Red: The battery is charging.



Solid Green: Fully charged.

Solid/Flashing Yellow or Off: The charger is in an abnormal protection state. Stop charging immediately and contact bike manufacturer for assistance.



A solid yellow light is normal when no battery is connected.

5.3 Battery Maintenance

-  It is recommended to tap **Battery** in the Avinox Ride app to set a charging limit.
 - The battery should be stored in a cool and dry environment without direct sunlight at a temperature from 0° to 40° C (32° to 104° F).
 - Regularly check the battery level and battery cycle counts. Battery capacity may be affected after using for 500 cycles, which will not impact riding.
 - Regularly inspect the battery. Do not use batteries with signs of damage, leaking fluid, or odor and contact bike manufacturer for assistance.
 - Charge the battery promptly when the power level drops below 10%, otherwise the battery life may be affected
 - Do not use alcohol, solvents, or abrasive cleaners to wipe the battery or charger. Use a clean, soft cloth for cleaning.
 - Battery performance will be affected if the battery is not used for an extended period. Discharge and charge the battery completely once every three months to keep it in good condition.
-
-  Do not store a battery for an extended period after fully discharging. Otherwise, the battery may over-discharge and cause irreparable damage to the battery cell.
 - For long-term storage, remove the battery from the frame and store it out of reach of children. It is recommended to store the battery at a 30% charge level to prevent battery aging or over-discharge.
 - When the battery is stored separately, keep the battery terminals away from metal objects to prevent short circuits.
 - Before transportation, discharge the battery to below 30%. For long-distance transportation or battery shipping, use a dedicated carrying box to prevent damage. Do not transport a damaged battery.
-

5.4 Disposal

-  Batteries, chargers, and electronic devices cannot be disposed of with household waste. Make sure to dispose of these items in an environmentally friendly way in accordance with local regulations. Ensure the power has completely run out before disposing of it.
-

6 Maintenance

6.1 Routine Maintenance

-  Before performing any cleaning or maintenance, ensure the system is powered off or set to Maintenance mode to prevent accidental startup and potential injury.
-

Drive Unit and Speed Sensor

- Use a soft-bristled brush to remove sand and debris from the housing, then wipe with a slightly damp cloth.
- Lift the rear wheel off the ground and rotate the cranks both forward and backward to check for any abnormal noise from the drive unit.
- Regularly check whether the drive unit mounting bolts are tightened to the specified torque.
- If internal components of the drive unit require replacement, strictly follow the instructions in the *Drive Unit Service Guide*. Due to the high difficulty, it is recommended to contact the bike manufacturer for assistance.
- Regularly check whether the speed sensor is correctly positioned. Misalignment will affect speed detection accuracy.
- Regularly clean the surface of the speed sensor and speed sensor ring to prevent obstruction by foreign objects.

Battery and Charger

- Regularly check the battery terminals. If oxidation, blackening, or dirt is found, wipe with a dry cloth or a specialized cleaner while the power is off.
- Ensure the battery plugs in smoothly and the connection is secure.
- Check the charging cable for damage, cracked insulation, or deformed plugs. If any damage is found, replace immediately.

Control Display and Wireless Controller

- Use a clean, soft cloth to wipe the screen to avoid scratches.
- If the screen is stained with oil, clean it using a small amount of water or a neutral cleaner. Never use alcohol or alkaline cleaners.
- Regularly check whether the control display mounting bolts are tightened to the specified torque. Over-tightening may damage the housing, while under-tightening may cause it to come loose while riding.

- Press the wireless controller buttons regularly to ensure they have crisp, tactile feedback without sticking. If the button response feels abnormal, foreign debris may be present. It is recommended to contact the bike manufacturer.

6.2 Replacing Battery of Controller

The indicator of the wireless controller will flash red when the battery level is too low. Follow the illustrations to replace the battery.

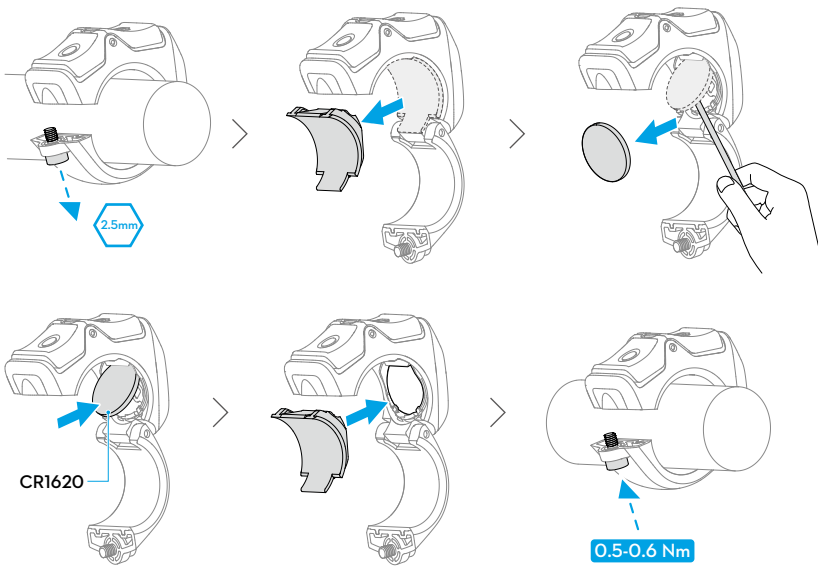

- ⚠ • Do not use metal tools to remove the battery as it may cause a short circuit.
- Make sure to clean the installation area and the bolts after repeated removals to prevent abnormal noise during installation and detachment.

7 Troubleshooting

When the drive system detects error, there will be a warning on the control display. Swipe up to enter Settings and tap **System Status** to learn the warning details and corresponding troubleshooting.

 If the issue persists, contact the bike manufacturer for help.

7.1 Uploading Log

If an error occurs or the system crashes during use, you can upload the log in the Avinox Ride app.

Drive System Errors

Tap  > **Help** > **Support**, and follow the instructions under **Drive System Errors** to export and send the logs to the bike manufacturer for analysis.

App Errors

Tap  > **Help** > **Support** > **App Errors** to submit any problems you encounter while using the app and get assistance.

This content is subject to change without notice.
Download the latest version from



<https://www.avinox-ebike.com/avinox-system/downloads>

AVINOX is a trademark of AVINOX.
Copyright © 2026 AVINOX All Rights Reserved.